



RGL101

Le RGL101 est un indicateur lumineux à leds destiné à indiquer dans un contexte radio les micros qui sont à l'antenne. Il s'intègre facilement entre une pince microphone et le pied du microphone. L'utilisation de leds permet une durée de vie très importante.

- Il s'adapte à tous microphones et à tous pieds de micro avec un filetage 5/8.
- Alimentation 24Volts/ 10mA

MONTAGE

☐ Pince Micro simple



☐ Montage SM7



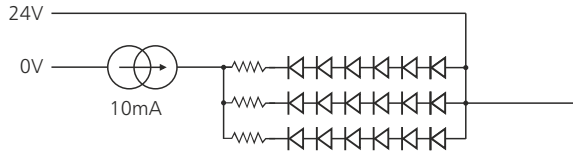

CABLAGE

☐ Câblage direct

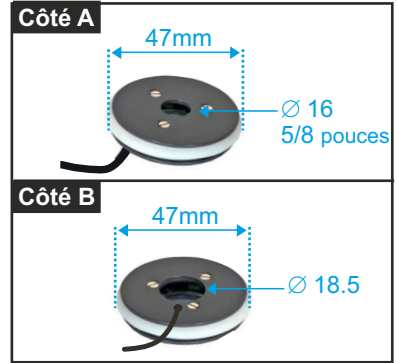
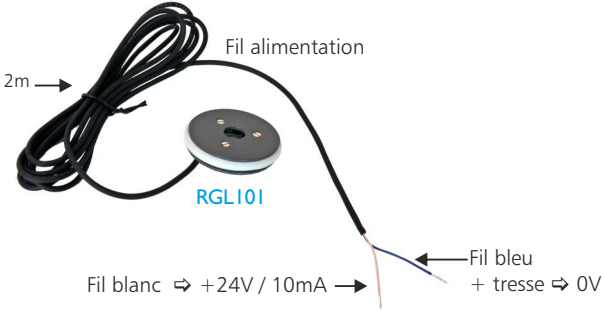

☐ Câblage avec ASM 100/110

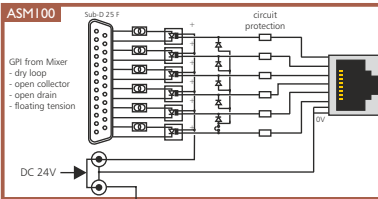

Vers un deuxième ASM100

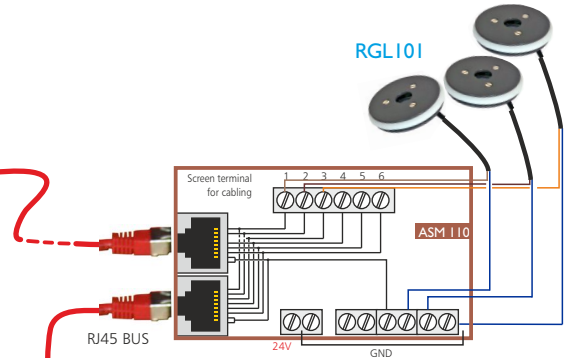

Il est possible de relier 6 micros sur un seul ASM110.

Mais vous pouvez rajouter un deuxième ASM110, puis un troisième (6 max) si la distance entre les micros est très importante

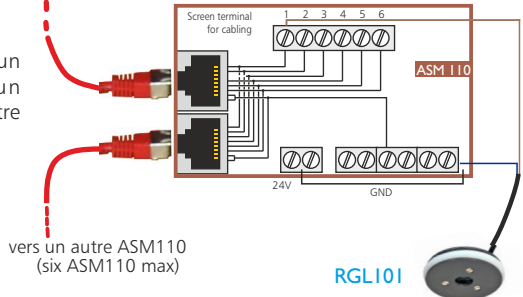

vers un autre ASM110
(six ASM110 max)



RGL101 is a light indicator, used to show the "ON AIR" microphones in a broadcasting environment. It fits easily between the microphone holder, and the microphone support. Use of led results in a very long life.

- It fits all microphones and microphone stands with a 5/8 thread.
- Power supply 24Volts/ 10mA

MOUNTING

Micro single clip



SM7 mounting



BLOCK DIAGRAM

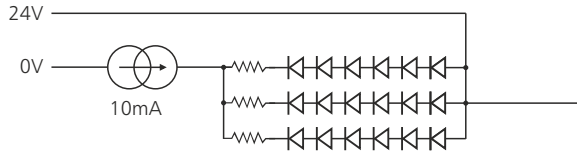

WIRING

Simple wiring

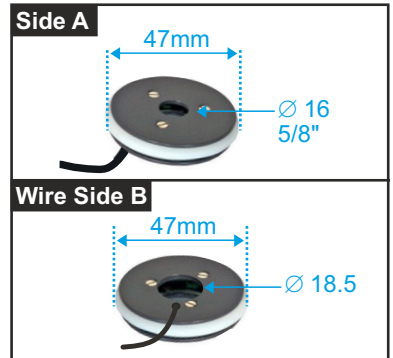
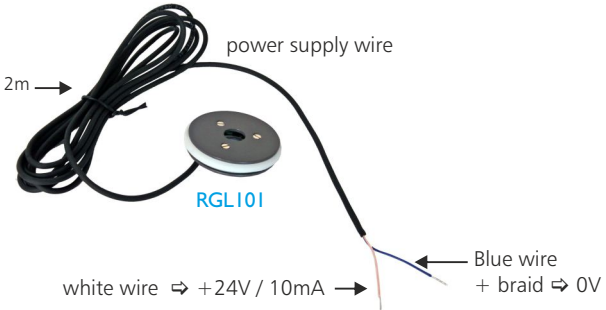

Wiring with ASM 100/110

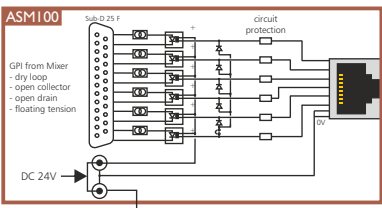

To a second card ASM100

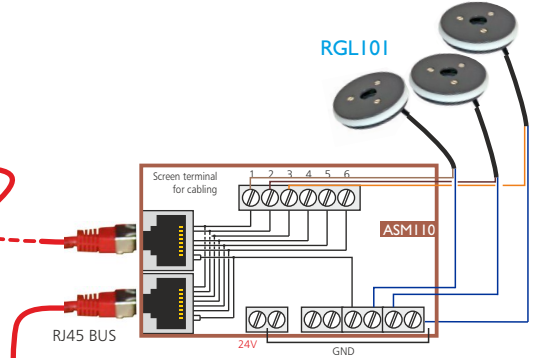

You can connect the six microphones on only one ASM110.

But you can use a second or third or more ASM110 if the distance between all the microphones is too large.

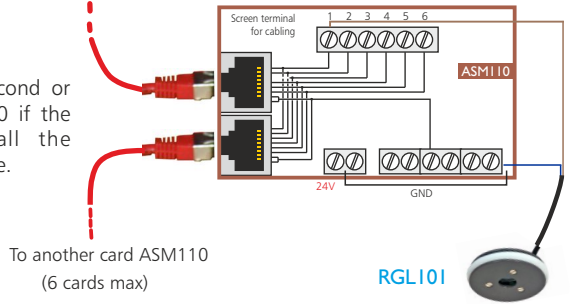

To another card ASM110 (6 cards max)